

# MULTI-BLADE FANS TYPE H-3

Aluminium  
Diameter – 108", 120", 132" & 144"  
9 Blades



Your Full-Service  
Cooling Technologies Company  
[www.paharpur.com](http://www.paharpur.com)

**PRECISION-MANUFACTURED FAN BLADES**

**PAHARPUR LEADS**

Each fan blade is factory balanced and precisely measured & matched with accompanying blades before shipping.

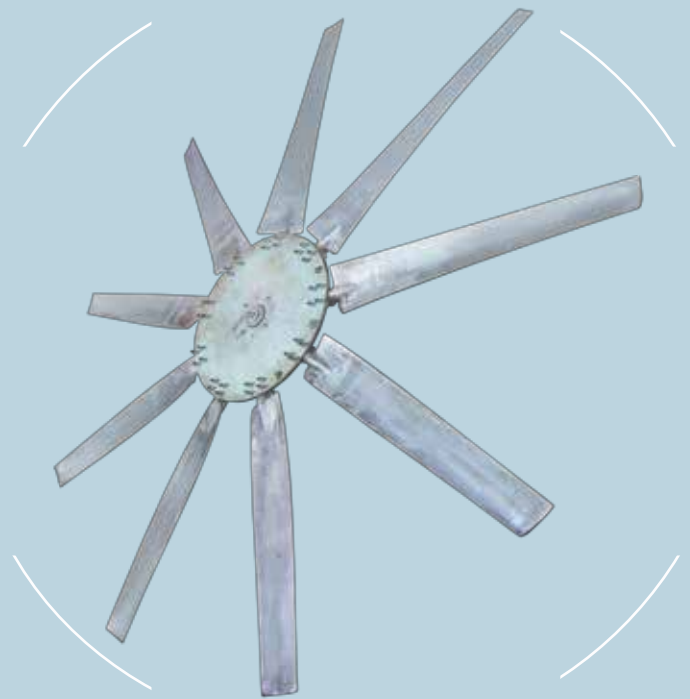

Paharpur designs and produces its own fan blades – these are factory **balanced, tested, measured and matched** to ensure stable operation, high reliability, longevity and operating economy in the rough conditions of the cooling tower.

Precision and uniformity in manufacturing helps significantly improve operating economy by giving better control over fan speed and power consumption

**Precision manufacturing ensures reliable operation:**

When it comes to fan efficiency, every millimetre matters – uniform width blade-tip clearance, pitch balancing and weight are of critical importance. Paharpur manufactures every blade specifically for every order to ensure uniformity among all fan blades supplied. This allows us to improve operating economy and ensure reliable performance.

**Maximum customisation:**

Paharpur has more than 00 fan diameters to choose from, under 00 fan types. Further, we can provide you with 00 types of fan hubs. This variety in material of construction, radius and design helps Paharpur provide the right combination for your cooling tower – giving Paharpur a truly unmatched advantage

while sizing your cooling tower. With maximum prospects for customisation, Paharpur can supply your with an industry-leading solution.

**Corrosion resistance enhances service life:**

Aluminium is naturally highly corrosion resistant and exhibits high durability in the moist conditions inside a cooling tower. Intelligent selection of component raw material affords a long and reliable service life to Paharpur's products.

**Statically balanced fans ensure dependability:**

Every fan blade supplied is statically-balanced at Paharpur's facility to ensure uniform weight distribution – this helps ensure the integrity of your cooling tower, saves fan power and helps maintain the reliability of your cooling operation.

**Variable-pitch provides control over power consumption:**

Paharpur gives you control over your cooling tower's power consumption by providing variable pitch blades for all fans. Control power consumption with varying heat load and wet bulb temperatures.

**Single-piece construction for high structural integrity:**

All Paharpur manufactured fan blades are made as single pieces; this helps maintain the structural integrity of the fan as joints can come under severe mechanical stress in rotating equipment. Single-piece construction means that you do not have to worry about the leading edge of the blade coming off during operation and cause damage to your equipment.

## BLADE-TIP CLEARANCE

### PRECISION MANUFACTURING ENSURES RELIABLE PERFORMANCE

UNIFORM BLADE-TIP-CLEARANCE  
UNIFORM RADIUS OF ALL BLADES

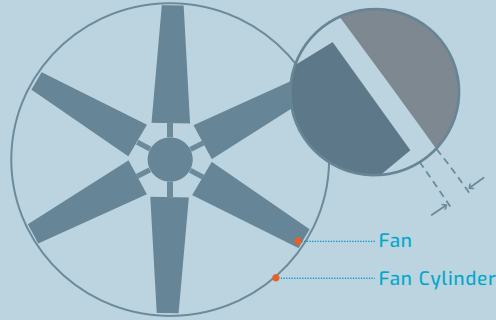

### MINIMUM BLADE-TIP CLEARANCE

The clearance between the blade-tip and cylinder is minimum for optimum utilisation of fan power.

Type H-3-9 fans of 108", 120", 132" and 144" diameters, with standard bores, are available for immediate shipment. Special assemblies of other diameters from 97" to 143" and/or with special bores are produced on order. The nine

aluminium blades are of twisted and tapered air foil design, precision cast in permanent molds. The shank is machined with a safety shoulder and is protected with glass reinforced Versamid epoxy resins to prevent

corrosion. Blade clamp is hot dip galvanized steel. Attachment hardware is stainless steel. The hub is a ductile iron casting, painted with gray epoxy paint. Hubs are machined with a groove to accept the blade shank safety

shoulder to accurately position the blade radially. Hubs are webbed between spokes to prevent air recirculation. Balance weights, as required, are attached to the hub.

## FAN PERFORMANCE DATA

The CFM shown is standard air : .075 lbs. per cubic foot equivalent to 700 dry air at sea level. Curves are based on model tests simulating AMCA procedures. The test cylinder was a laminated eased inlet cylinder with tip seal and tip clearance equal to 47% of the fan diameter. Tip clearances, fan cylinder and system characteristics can cause variation from the curves shown alongside.

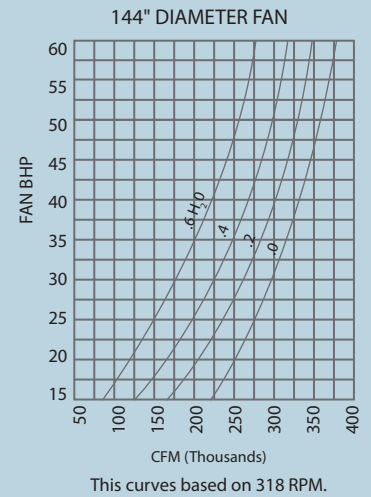
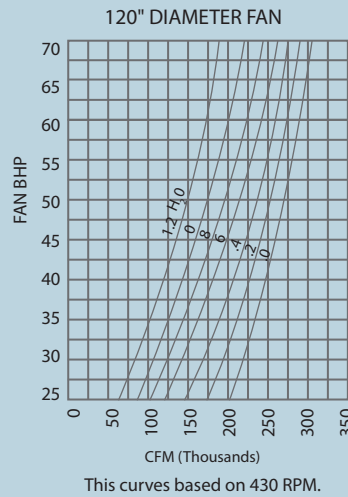
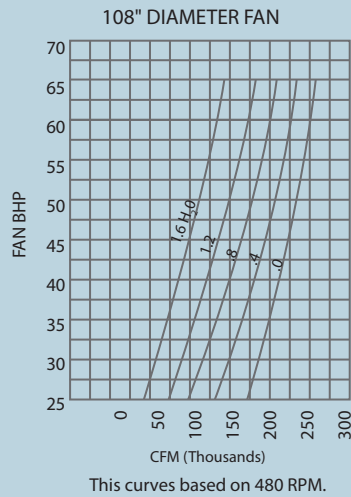

## Fibre Glass Nacelle Hub Cover and Blade Seal

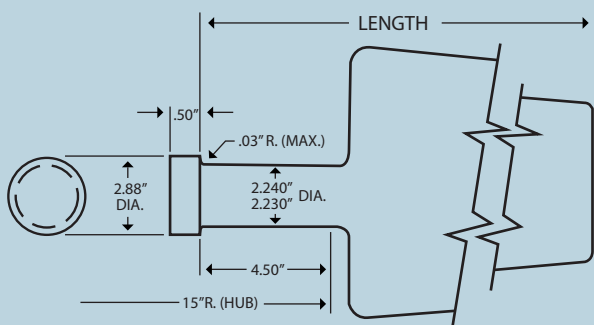
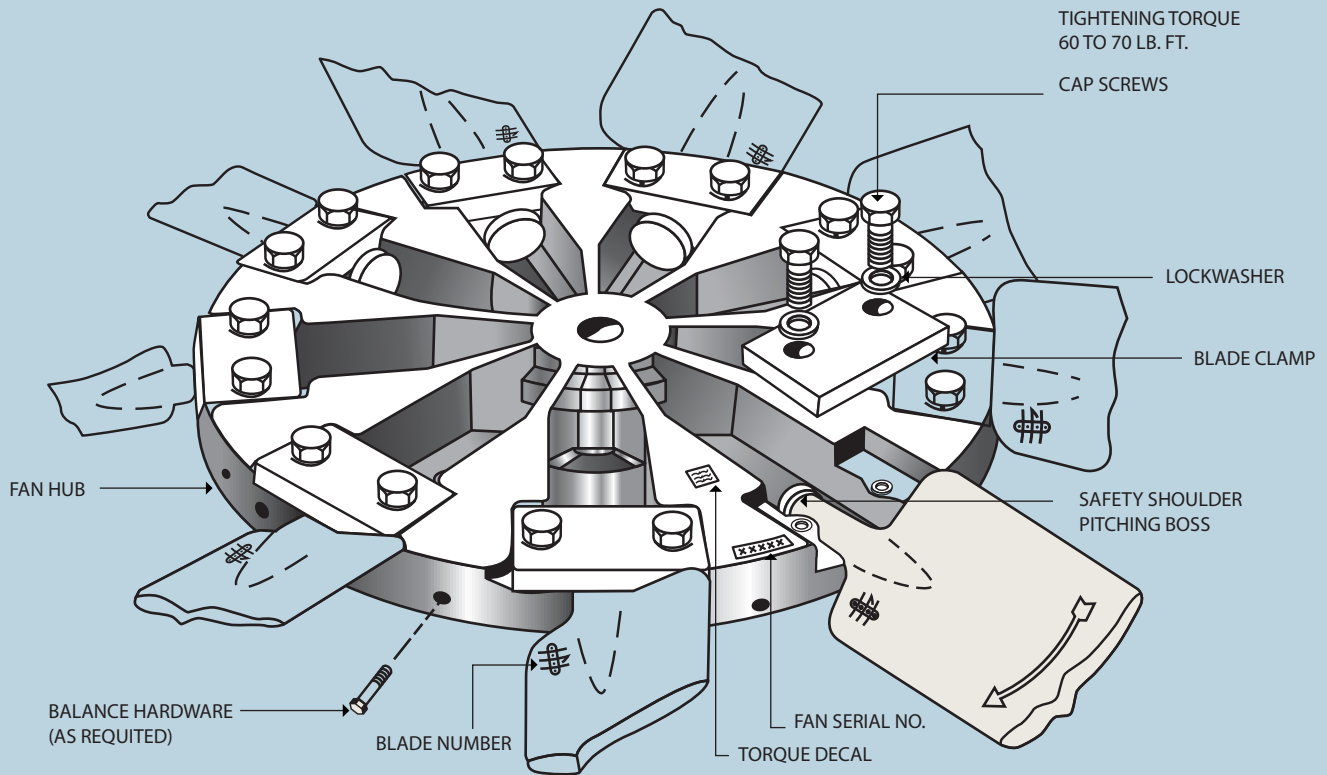

Width and thickness of standard blades for the 108", 120", 132" and 144" fans decrease from inboard end to tip of blade as follows:

FAN DIA.	APPROX WIDTH		MAXIMUM THICKNESS	
	MAX.	MIN.	INBOARD	OUTBOARD
108"	9-1/2"	6-3/4"	7/8"	1/2"
120"	9-1/2"	6-3/8"	7/8"	1/2"
132"	9-1/2"	6-1/8"	7/8"	7/16"
144"	9-1/2"	5-7/8"	7/8"	7/16"



Your Full-Service  
Cooling Technologies Company  
www.paharpur.com

## STANDARD CROSS SECTION SHOWING HUB, HUB COVER AND BLADE DIMENSIONS

FAN DIA.	A*	B*
180"	2-1/16"	1-3/16"
120"	1-7/8"	1"
132"	1-3/4"	7/8"
144"	1-5/8"	13/16"

\*Dimensions of blade above and below fan centre line at maximum pitch of 510 on picthing boss.

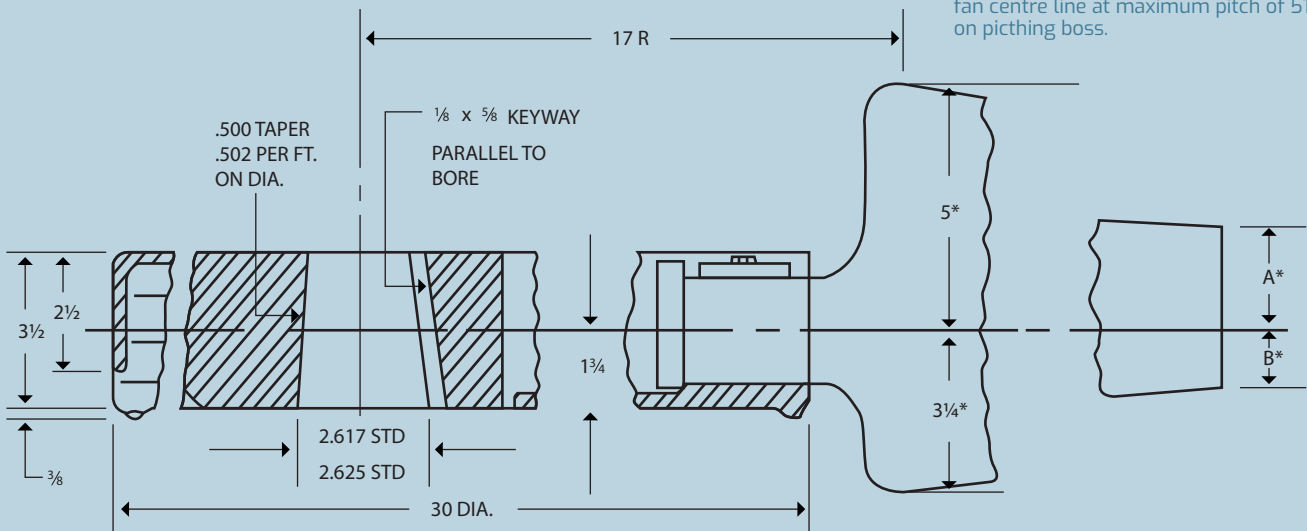

Refer to STATIC PRESSURE and PERFORMANCE Limit curves for speed, bore and keyway data. Minimum bore (without bushing) 1.7/8".

DIA.	NO. OF BLADES	BLADE LENGTH	MAX. TIP SPEED FPM	APPROX. WT. EACH BLADE	APPROX. WT. HUB	APPROX. TOTAL SHIPPING WT.	RADIAL TIP CLEARANCE	
							MIN.*	MAX.
108"	9	43.50"	14,700	19-1/4 lbs.	158 lbs.	420 lbs.	1/2"	3/4"
120"	9	49.50"	14,230	20-3/4 lbs.	158 lbs.	430 lbs.	1/2"	3/4"
132"	9	55.50"	12,300	21-3/4 lbs.	158 lbs.	440 lbs.	1/2"	3/4"
144"	9	61.50"	12,000	22-3/4 lbs.	158 lbs.	450 lbs.	1/2"	3/4"

Speed Range to Avoid : 108" 374 to 414 RPM. • 120" 381 to 421 RPM. • 132" 308 to 340 RPM. • 144" 248 to 269 RPM.

\*Minimum clearance at tip of trailing edge.

**PAHARPUR LEADS**

**PAHARPUR COOLING TOWERS LTD.**

Paharpur House  
8/1/B Diamond Harbour Road  
Kolkata 700027, India  
Ph : +91 33 4013 3000  
Fax : +91 33 4013 3499  
pctccu@paharpur.com



Your Full-Service  
Cooling Technologies Company  
www.paharpur.com



**INDIAN SALES OFFICES**

**CHENNAI**

2G, Vishwapriya Apartment –  
3rd floor, Kasthuribhai Nagar,  
1st Cross Street, Adyar  
Chennai 600020  
Ph : +91-44-2490 0275  
+91-44-2490 3109  
Fax : +91-44-2490 3117  
E-Mail : pctmaa@paharpur.com

**BENGALURU**

Paharpur House  
41 Cunningham Road Cross  
Bangalore 560052  
Ph : +91-80-2226 5566-7  
+91-80-2234 1911  
Fax : +91-80-2225 3999  
E-Mail : pctblr@paharpur.com

**HYDERABAD**

3rd Floor, "The Grand"  
6-3-1090/B/4, Raj Bhavan Road  
Somajiguda  
Hyderabad 500082  
Ph : +91-40-2331 7081-3  
Fax : +91-40-2331 7081  
E-Mail : pcthyd@paharpur.com

**MUMBAI**

506 Navkar Chambers, 5th Floor  
'B'Wing, Andheri-Kurla Road  
Andheri (East)  
Mumbai 400059  
Phone : +91-22-4043 2432  
+91-22-2859 5924-26  
Fax : +91-22-2851 4913  
E-Mail : pctbom@paharpur.com

**NEW DELHI**

806 Ashoka Estate  
24 Barakhamba Road  
New Delhi 110001  
Ph : +91-11-2335 7846-50  
+91-11-2331 0826  
Fax : +91-11-2335 7851  
E-Mail : pctdel@paharpur.com

**VADODARA**

Plot No. 132 KV-I  
Manjusar-Savli GIDC  
Ta. : Savli, Dist. : Vadodara 391775  
Gujarat  
Ph : +91-2667- 264331-32  
Fax : +91-2667-264333  
E-Mail : pctbdq@paharpur.com

**INTERNATIONAL SALES OFFICES**

Lugano, Switzerland  
Izmir, Turkey  
Beijing, China  
Seoul, South Korea  
Denver / Bridgewater/  
Overland Park, USA

Brussels, Belgium  
Stabio, Switzerland  
Varese, Italy  
Madrid, Spain  
Lagos, Nigeria  
Mexico City, Mexico

An ISO 9001:2015,  
ISO 14001:2015 &  
OSHAS 18001:2007  
certified company

[www.paharpur.com](http://www.paharpur.com)

**PAHARPUR LEADS**

**Disclaimer:**

Paharpur's policy of continued improvement may necessitate data to be changed without notice. For the latest information, please contact Paharpur.